

bycool!
green line

DINAMIC 1.1
24V

Manual del Usuario

User's handbook

Manuel de l'utilisateur

Benutzerhandbuch

Manuale Per l'utente

ES

EN

FR

GE

IT



1002430924

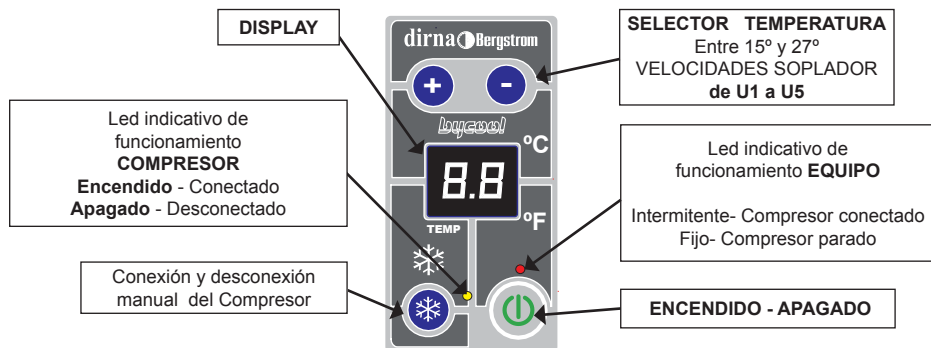

El equipo tiene dos modos de funcionamiento:

F4 Modo Automático.

F0 Modo Manual.

Otras Funciones:

F1 Termómetro digital.

F2 Programación Tiempo.

F5 Selección °F (Fahrenheit).



ATENCIÓN:

Si durante el montaje el equipo se inclina ó se abate la cabina con el equipo montado, se deberá esperar un mínimo de 60 minutos, desde que el equipo quede horizontal, antes de ponerlo en marcha.

Al arrancar el equipo entra automáticamente en Modo **F4** (automático). Manteniendo pulsada la tecla **ON/OFF**, se ira cambiando a las funciones que aparecieran en el display **F4, F0, F1, F2, F3**. Soltar en la opción deseada.

Función de teclas del mando

1 ENCENDIDO - APAGADO

Nota: Al pulsar este botón el equipo se enciende en modo automático **F4**.

2 Control de las velocidades del soplador (sólo modo manual).



Nota: estando encendido el equipo en modo automático **F4** si el usuario actúa sobre esta tecla, el equipo pasa a modo manual **F0**. De este modo el usuario podrá elegir el flujo de aire deseado pulsando sobre esta tecla, apareciendo en el display las siglas **U1, U2, U3, U4, U5, U4, U3, U2, U1**

3 SELECTOR TEMPERATURA



- Entre 15 y 27° C - 59-80° F



PARA DAR DE ALTA EL MANDO A DISTANCIA

- Con el equipo apagado, mantener pulsada la tecla  del panel de control hasta que aparezca en el display  parpadeando. Cuando quede fijo, tocar cualquier tecla del mando y quedará reconocido. Si en 30 segundos no se pulsa ninguna tecla del mando, el equipo se apagará. *(Se pueden programar hasta 5 mandos para un mismo equipo).*



PARA DAR DE BAJA

- Para borrar cualquier mando programado se pulsa continuamente la tecla  del panel de control, hasta que aparezca en el display  y a continuación pulsar la tecla .

Todos los mandos dados de alta quedan automáticamente anulados. (No dejar transcurrir mas de 30 segundos entre pulsar una tecla y otra o quedará apagado el equipo).



F4 Funcionamiento Automático del equipo



En el display aparecerá  alternativamente con la temperatura seleccionada. Si la temperatura es superior a 32° en el interior del vehículo al poner el equipo en funcionamiento, el soplador y el compresor entran al máximo de rendimiento durante 20 minutos aproximadamente, a partir de ese momento el soplador y el compresor regulan su capacidad de rendimiento, dependiendo de la temperatura interior.



  Pulsando una sola vez, en una u otra tecla, se elige la temperatura deseada, entre 15° y 27° C - 59-80° F

F0 Funcionamiento Manual del equipo

En esta función el compresor entra al máximo rendimiento con la mínima velocidad de aire, El compresor se activa o desactiva según temperatura seleccionada en el display.

Manteniendo pulsada , va aumentando la velocidad del soplador y aparece en el display  soltar en la velocidad deseada.

Manteniendo pulsada , va disminuyendo la velocidad del soplador y aparece en el display  soltar en la velocidad deseada.

  Pulsando una sola vez, en una u otra tecla, se elige la temperatura deseada, entre 15° y 27° C - 59-80° F



El compresor y el ventilador del condensador se conectan y desconectan automáticamente al llegar a la temperatura elegida. (Ejem. temperatura elegida 23°, el compresor y el ventilador del condensador se desconectan a 21° y vuelven a conectar a 24°).



Módulo termómetro digital

Va marcando la temperatura interior del vehículo. En este modo de funcionamiento, el equipo está apagado.

Programación de tiempo

Horas de funcionamiento y apagado de 0 a 9 horas. En 0 horas no temporiza, está en funcionamiento manual .

Para seleccionar las horas, lo haremos con las teclas  .

Elegir la hora que aparece en el display, 1H (una hora), 2H (dos horas)...9H (nueve horas), y pulsar la tecla **On/Off**  seleccionar  ó , el equipo se pondrá en marcha el tiempo seleccionado y se parará al terminar este periodo.



Mensajes de Error

Si al conectar la batería emite pitidos continuos la cinta se encuentra desconectada o mal conectada.

 - Fallo sensor aire de retorno.

 - Batería baja menos de 22.8 V.

 - Fallo ventilador de condensador o soplador.

 - Fallo compresor (Causas: motor, cableado, conector, falta o exceso de carga).

 - Fallo por calentamiento del módulo electrónico del compresor.

 - Fallo sensor antihielo.



Importante

En algunos casos de mensajes de error, para apagar el equipo, mantener pulsada la tecla **On/Off**  hasta que el display se apague.



Importante

Si durante el funcionamiento se apaga el equipo, la causa puede ser:

- Cable de comunicación desconectado o fusible fundido.
- Fusible fundido de alimentación del equipo.

Esquema eléctrico

¡AVISO IMPORTANTE!
 Precaución de no invertir las polaridades al conectar la alimentación al equipo. Si esto sucediera, el panel de control no se enciende y el equipo no funciona.

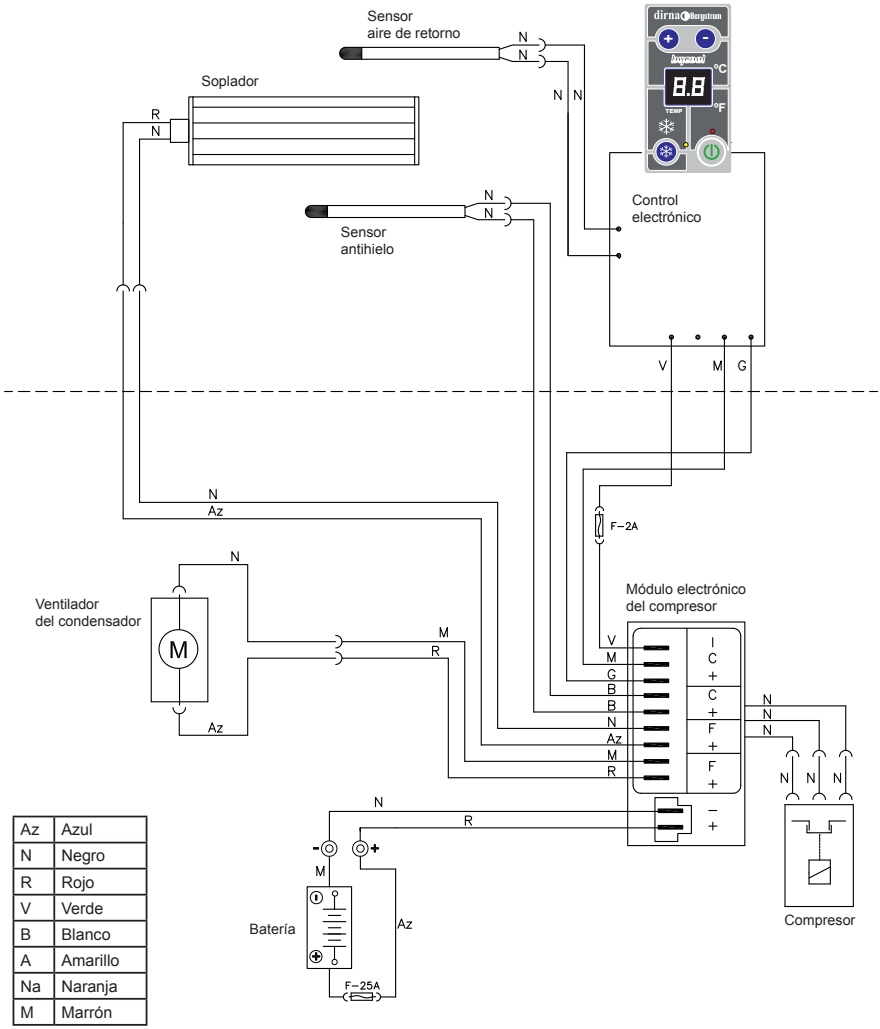

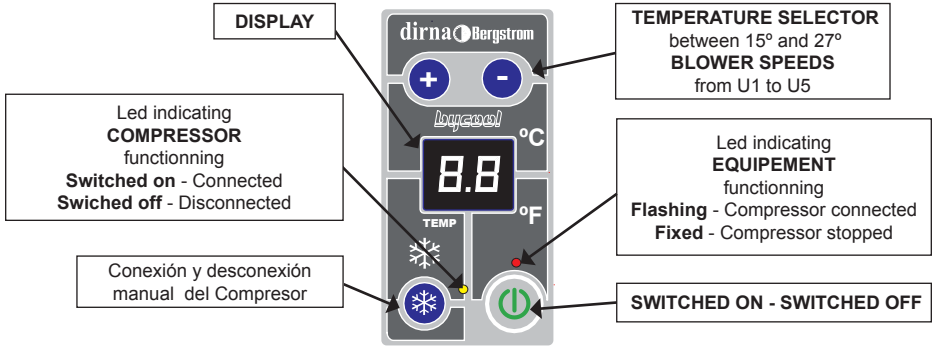

The equipment has two functioning modes:

F4 Automatic mode.

F0 Manual mode.

Other functions:

F1 Digital thermometer.

F2 Time programming.

F3 °F Selection (Fahrenheit).



NOTE:

If, during assembly, the unit becomes slanted or the cabin drops with the unit mounted, wait for at least 60 minutes from the moment the unit is horizontal before starting up.

When starting, equipment will automatically be in Mode **F4** (automatic). Manteniendo If **ON/OFF** key is maintained pressed, functions will change as they appear on display **F4, F0, F1, F2, F3**. Release on desired option.

Function of control keys

1 SWITCHING ON/OFF.

Note: when this Key is pushed, the unit starts in automatic mode **F4**.

2 Blower speed control (manual mode only)



Note: while the unit is working in automatic mode **F4**, if the user press this key, the unit will change the working mode to manual **F0**. This allows the user to choose the desired air flow by pushing this key and the following symbols will appear on the display: **U1, U2, U3, U4, U5, U4, U3, U2, U1**.

3 TEMPERATURE SELECTOR



- Between 15° and 27° C - 59-80° F



TO ACTIVATE REMOTE CONTROL

- With the unit off, keep the  key pressed down on the control panel until  flashes on the display. When it stops flashing, touch any control key for it to be recognised. The unit will go off if no control key is pressed in 30 seconds. *(Up to 5 controls can be programmed for a single item of equipment).*



TO DISABLE REMOTE CONTROL

- In order to delete any programmed control, keep the control panel  key pressed down until  appears on the display, and then press the  key.

All activated controls are automatically cancelled *(do not wait more than 30 seconds between pressing one key and the other or equipment will be switched off).*

Automatic functioning

 will appear on display, alternatively with the selected temperature. If temperature is above 32° inside vehicle, when equipment is switched on, blower and compressor go into maximum power for about 20 minutes, then blower and compressor regulate their capacity depending on inside temperature.



  By pushing , one key or the other, desired temperature is chosen, between 15° and 27° C - 59-80° F

Manual functioning

With this function, compressor goes into maximum power with minimum air speed. Compressor is activated or deactivated according to temperature selected on display.

By maintaining , pushed, blower speed increases and *W1, W2, W3, W4, W5* appear on display. Release on desired speed.

By maintaining , pushed, blower speed decreases and *W1, W2, W3, W4, W5* appear on display. Release on desired speed.

  By pushing only once, one key or the other, desired temperature is chosen, between 15° and 27° C - 59-80° F



The condenser fan and compressor connect and disconnect automatically when the chosen temperature is reached. (e.g. chosen temperature 23°, the compressor and the condenser fan disconnect at 21° and reconnect at 24°).

Digital thermometer module

It indicates temperature inside vehicle. In this functioning mode, equipment is switched off.

Time programming

Hours de functioning and switching off from 0 to 9 hours. On 0 hour, it does not temporise, it is in manual functioning **F0**.

To select hours, user will employ   keys.

Choose hour which appears on display, 1H (one hour), 2H (two hours)...9H (nine hours), and push **On/Off**  select **F4** ó **F0**, equipment will be working during selected time and will stop when this time period is over.



Error messages

If when equipment is switched on, it makes continuous noises, it means that keyboard is badly connected or not connected.

- E0** - Return air sensor failure.
- E1** - Low battery, less than 22.8V.
- E2** - Condenser or blower fan failure.
- E3** - Compressor failure (Causes: engine, wiring, connector, lack or excess of charge)
- E5** - Compressor electronic module failure due to heating.
- E6** - Anti-ice probe failure.



Important

In some cases of mistake message, to swith off the unit keep the **On/Off** button  pushed till the screen switches off.



Important

If the unit goes off during operation, the cause may be:

- Communication cable disconnected or fuse blown.
- Unit's power fuse blown.

Electric wiring

IMPORTANT NOTE!
 Take care not to invert polarities when connecting the unit to the power supply. If this happens, the control panel does not come on and the unit does not work.

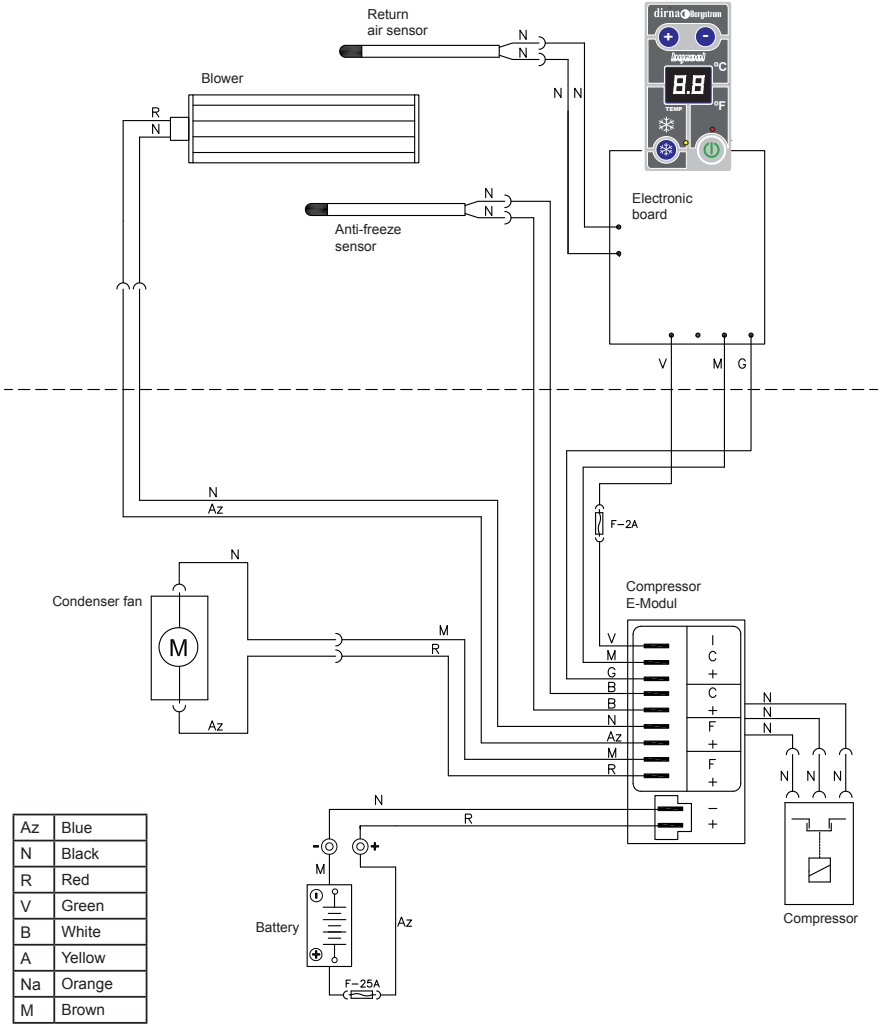

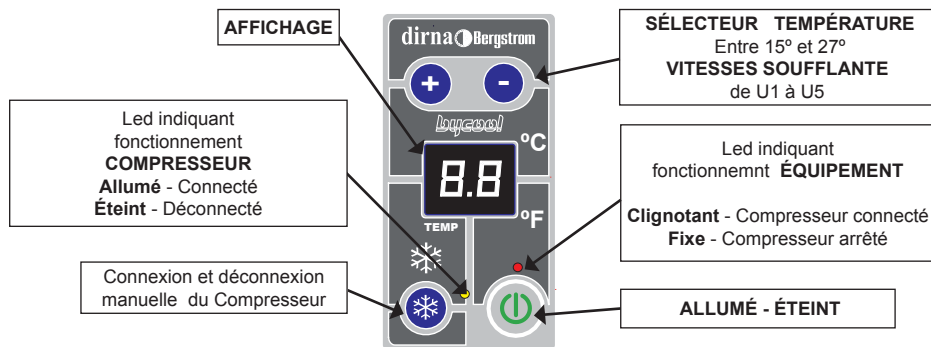

L'équipement a deux modes de fonctionnement:

F4 Mode automatique.

F0 Mode manuel.

Autres fonctions:

F1 Thermomètre numérique.

F2 Programmation temps.

F3 Sélection ° F (Fahrenheit).



ATTENTION :

Si pendant le montage, l'équipement s'incline ou si la cabine est repliée avec l'équipement monté, une fois que ce dernier récupère sa position horizontale, il faudra attendre au moins 60 minutes avant de le remettre en marche.



Au démarrage, l'équipement entre automatiquement en Mode **F4** (automatique). Si l'on maintient la touche **ON/OFF**, les fonctions changeront et apparaîtront à l'affichage **F4, F0, F1, F2, F3**. Relâcher lorsque l'option désirée est affichée.

Fonction des touches de la commande



- ① **ALLUMAGE - ARRÊT.**
Note: En appuyant sur ce bouton l'appareil s'allume dans le mode automatique **F4**.
- ② Contrôle des vitesse du souffleur (mode manuel uniquement)
Note: si l'appareil est allumé en mode automatique **F4**, si l'utilisateur appuie sur cette touche, l'appareil passe au mode manuel **F0**. l'utilisateur peut ainsi choisir le débit d'air souhaité en appuyant sur cette touche. Les sigles **U1, U2, U3, U4, U5, U4, U3, U2, U1** s'affichent au display.
- ③ **SÉLECTEUR TEMPÉRATURE**
- Entre 15° et 27° C - 59-80° F



POUR ACTIVER LA COMMANDE À DISTANCE

- Avec l'équipement éteint, appuyer pendant quelques secondes sur la touche  du panneau de commande jusqu'à ce que l'écran affiche  en clignotant. Une fois fixe, appuyer sur une touche quelconque de la commande et il sera reconnu. Si aucune touche de la commande n'est sélectionnée pendant 30 secondes, l'équipement s'éteindra (*il est possible de programmer jusqu'à 5 commandes pour un même équipement*).



POUR DÉSACTIVER LA COMMANDE À DISTANCE

- Pour effacer une commande programmée, il faut appuyer de façon continue sur la touche  du panneau de commande, jusqu'à ce que l'écran affiche  et appuyer ensuite sur .

Toutes les commandes activées sont automatiquement annulées. (*Ne pas attendre plus de 30 secondes entre le fait d'appuyer sur une touche et une autre ou l'appareil s'arrêtera*).

Fonctionnement automatique

Sur l'affichage apparaîtra  alternativement avec la température choisie. Si la température est supérieure à 32° à l'intérieur du véhicule, lorsque l'équipement est mis en marche, la soufflante et le compresseur se mettent au rendement maximum pendant environ 20 minutes. À partir de ce moment, la soufflante et le compresseur régulent leur capacité de rendement, en fonction de la température intérieure.



  En appuyant, sur une touche ou sur l'autre, la température souhaitée est choisie, entre 15° et 27° C - 59-80° F

Fonctionnement manuel

Dans cette fonction, le compresseur se met au rendement maximum avec la vitesse d'air la plus basse. Le compresseur est activé ou désactivé selon la température sélectionnée à l'affichage.

En maintenant la touche appuyée , la vitesse de la soufflante augmente et apparaissent à l'affichage *U1, U2, U3, U4, U5* relâcher lorsque la vitesse désirée est affichée.

En maintenant la touche appuyée , la vitesse de la soufflante diminue et apparaissent à l'affichage *U1, U2, U3, U4, U5* relâcher lorsque la vitesse désirée est affichée

  En appuyant une seule fois, sur une touche ou sur l'autre, la température souhaitée est choisie, entre 15° et 27° C - 59-80° F

Le compresseur et le ventilateur du condenseur se connectent et déconnectent automatiquement après avoir atteint la température choisie. (*Par ex., la température choisie est de 23°. Le compresseur et le ventilateur du condenseur se déconnectent à 21° et se reconnectent à 24°*).



Módulo thermomètre numérique

Il indique la température intérieure du véhicule. Dans ce mode de fonctionnement, l'équipement est éteint.

Programmation temps

Heures de fonctionnement et arrêt de 0 à 9 heures. À 0 heure, il ne temporise pas, il est en fonctionnement manuel .

Pour sélectionner les heures, l'utilisateur emploiera les touches  .

Choisir l'heure apparaissant à l'affichage, 1H (une heure), 2H (deux heures)...9H (neuf heures), et appuyer sur la touche **On/Off**  puis sélectionner  ou , l'équipement se mettra alors en marche pendant le temps sélectionné et s'arrêtera lorsque cette période sera terminée.



Messages d'erreur

Si au moment où l'utilisateur connecte la batterie, l'équipement émet des sifflements continus, cela signifie que le clavier est mal connecté ou n'est pas connecté.

 - Défaut capteur air de retour.

 - Batterie faible moins de 22.8V.

 - Défaut ventilateur de condenseur ou souffleur.

 - Défaillance compresseur (Causes: moteur, câblage, connecteur, manque ou excès de charge).

 - Défaut par chauffage du module électronique du compresseur.

 - Défaut capteur antigel.



Important

Dans certains cas de messages d'erreurs, pour éteindre l'appareil. Il est nécessaire de maintenir la touche On/Off  jusqu'à l'extinction de l'afficheur.



Important

Si l'équipement s'éteint pendant le fonctionnement, la cause peut être la suivante :

- Câble de communication déconnecté ou fusible grillé.
- Fusible d'alimentation de l'équipement grillé.

Schéma électrique

AVIS IMPORTANT!

Attention de ne pas inverser les polarités au moment de connecter l'alimentation à l'équipement. Si cela se produisait, la plaque de commande ne s'allumerait pas et l'équipement ne fonctionnerait pas.

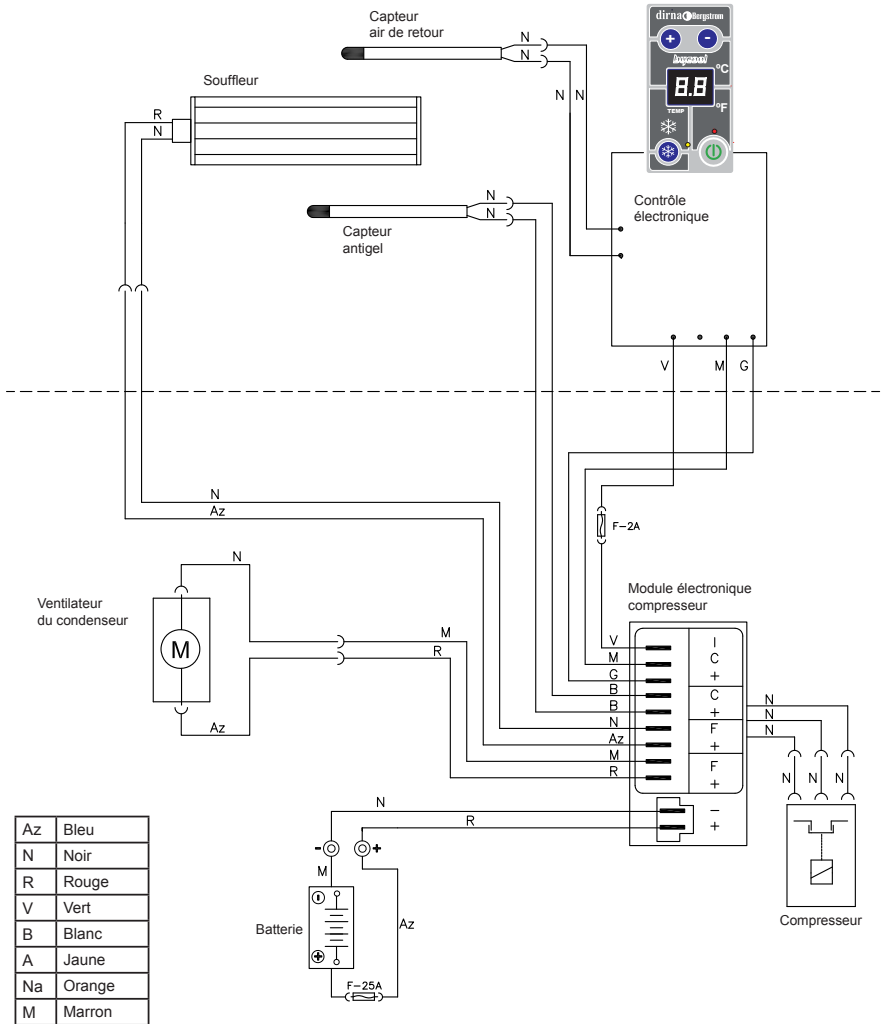

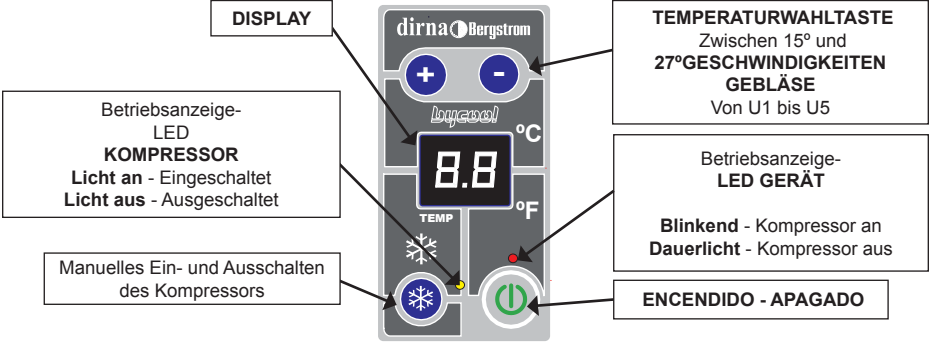

Das Gerät verfügt über zwei Betriebsarten :

- F4 Automatikbetrieb.
- F0 Handbetrieb.

Weitere Funktionen:

- F1 Digitale Temperaturmessung.
- F2 Timerprogrammierung.
- F3 Auswahl ° F (Fahrenheit).



ACHTUNG:

Sollte das Gerät während des Einbaus ins Schwanken geraten oder die Kabine umkippen, muss man von dem Moment, wo sich das Gerät wieder in waagerechter Stellung befindet, mindestens 60 Minuten abwarten bis es in Betrieb genommen werden kann.



Beim Starten des Geräts geht dieses automatisch in den **F4 Betrieb** (Automatik). Hält man die **ON/OFF**, Taste gedrückt, wird zu den auf dem Display erscheinenden Funktionen **F4, F0, F1, F2, F3**. gewechselt. Taste auf der gewünschten Option loslassen.

Tastenfunktionen



- Ein- / Ausschalten der Anlage (On/ Off).**
Hinweis: Durch Drücken dieser Taste schaltet sich die Anlage in der Betriebsart Automatik **F4**.
- Steuerung der Gebläsedrehzahl (nur in der Betriebsart Manuell).**
Hinweis: Befindet sich die Anlage in der Betriebsart Automatik **F4**, und betätigt der Benutzer diese Taste, wechselt die Anlage in die Betriebsart Manuell **F0**. So kann der Benutzer den gewünschten Luftstrom durch Drücken dieser Taste wählen, wobei auf dem Display die Angaben **U1, U2, U3, U4, U5, U4, U3, U2, U1**.
- TEMPERATURWÄHLER**
- Zwischen 15° und 27° C - 59-80° F



AKTIVIEREN DER FERNBEDIENUNG

- Bei abgeschalteter Anlage die Taste  des Bedienfelds gedrückt halten, bis auf dem Display  anfängt zu blinken. Wenn die Anzeige kontinuierlich leuchtet, eine beliebige Taste der Fernbedienung drücken, damit diese erkannt wird. Wird innerhalb von 30 Sekunden keine Taste der Fernbedienung gedrückt, schaltet sich die Anlage aus. *(Es können bis zu 5 Fernbedienungen für eine Anlage programmiert werden).*



FERNBEDIENUNG DEAKTIVIEREN

- Zum Löschen einer programmierten Fernbedienung die Taste  des Bedienfelds gedrückt halten, bis auf dem Display  erscheint; dann die Taste  drücken.

Alle aktivierten Fernbedienungen werden auf diese Weise gelöscht. *(Zwischen dem Betätigen einer und einer zweiten Taste dürfen nicht mehr als 30 s verstreichen, da sich anderenfalls das Gerät ausschaltet).*

Automatikbetrieb

Auf dem Display erscheint  wechselweise mit der vorgewählten temperatur. Ist die Temperatur im Fahrzeuginneren bei der Inbetriebnahme des Geräts höher als 32°, arbeiten Gebläse und Kompressor ca. 20 Minuten lang mit maximaler Leistung; danach regulieren Gebläse und Kompressor ihre Geschwindigkeit in Abhängigkeit von der Innentemperatur.

  Durch einmaliges Drücken einer der Tasten wird die gewünschte Temperatur zwischen 15° und 27° C - 59-80° F gewählt.

Handbetrieb

Bei dieser Funktion arbeitet der Kompressor mit maximaler Leistung bei minimaler Luftbewegung. Der Kompressor schaltet sich je nach der im Display gewählten Temperatur ein oder aus.

Wird , gedrückt gehalten, erhöht sich die Geschwindigkeit des Gebläses und auf dem Display erscheint *U1, U2, U3, U4, U5* Bei der gewünschten Geschwindigkeit Taste loslassen.

Wird , gedrückt gehalten, vermindert sich die Geschwindigkeit des Gebläses und auf dem Display erscheint *U1, U2, U3, U4, U5* Bei der gewünschten Geschwindigkeit Taste loslassen.

+ **-** Durch einmaliges Drücken einer der Tasten wird die gewünschte Temperatur zwischen 15° und 27° C - 59-80° F gewählt.

Der Kompressor und der Kondensatorlüfter schalten sich automatisch ein und aus, wenn die eingestellte Temperatur erreicht wird. *(Beispiel: Eingestellte Temperatur 23°, der Kompressor und der Kondensatorlüfter schalten sich bei 21° aus und bei 24° wieder an)*



Digitale Temperaturmessung

Anzeige der Innentemperatur des Fahrzeugs. Bei dieser Betriebsart ist das Gerät abgeschaltet.

Timerprogrammierung

Ein- und Ausschaltzeiten zwischen 0 und 9 Stunden. Bei 0 Stunden findet keine Programmierung statt, das Gerät ist im Handbetrieb .







Die Auswahl der Stunden erfolgt mit den Tasten **+** **-**.

Die auf dem Display erscheinende Stunde auswählen, 1H (eine Stunde), 2H (zwei Stunden)...9H (neun Stunden) und die **On/Off**  Taste drücken  oder , wählen, das Gerät ist dann während der ausgewählten Zeit in Betrieb und schaltet sich nach diesem



Fehlermeldungen

Gibt das Gerät beim Einschalten andauernde Pieptöne ab, ist die Tastatur nicht oder nicht richtig angeschlossen.

-  - Störung Abluftsensor.
-  - Batterie schwach unter 22.8 V.
-  - Störung Kondensatorlüfter oder Gebläse.
-  - Störung Kompressor (Grunde: motor, verkabelung, stecker, Fehlende oder übermäßige Ladung)
-  - Störung durch Erhitzung des Elektronikmoduls des Kompressors.
-  - Störung Frostschutzfühler.

**Achtung**

Wenn sie das gerat in jemanden fehlermeldungen ausmachen möchten, drücken sie die On/Off  taste bis das bildschirm sich aysmacht.

**Achtung**

Schaltet sich die Anlage während des Betriebs aus, kann dies folgende Ursachen haben:

- Kommunikationskabel nicht angeschlossen oder Sicherung geschmolzen.
- Sicherung der Stromversorgung der Anlage geschmolzen.

Elektrisches schaltschema

WICHTIGER HINWEIS!
 Darauf achten, dass die Polaritäten beim Anschluss der Stromversorgung an die Anlage nicht vertauscht werden. Ist dies der Fall, schaltet sich das Bedienfeld nicht an und die Anlage funktioniert nicht.

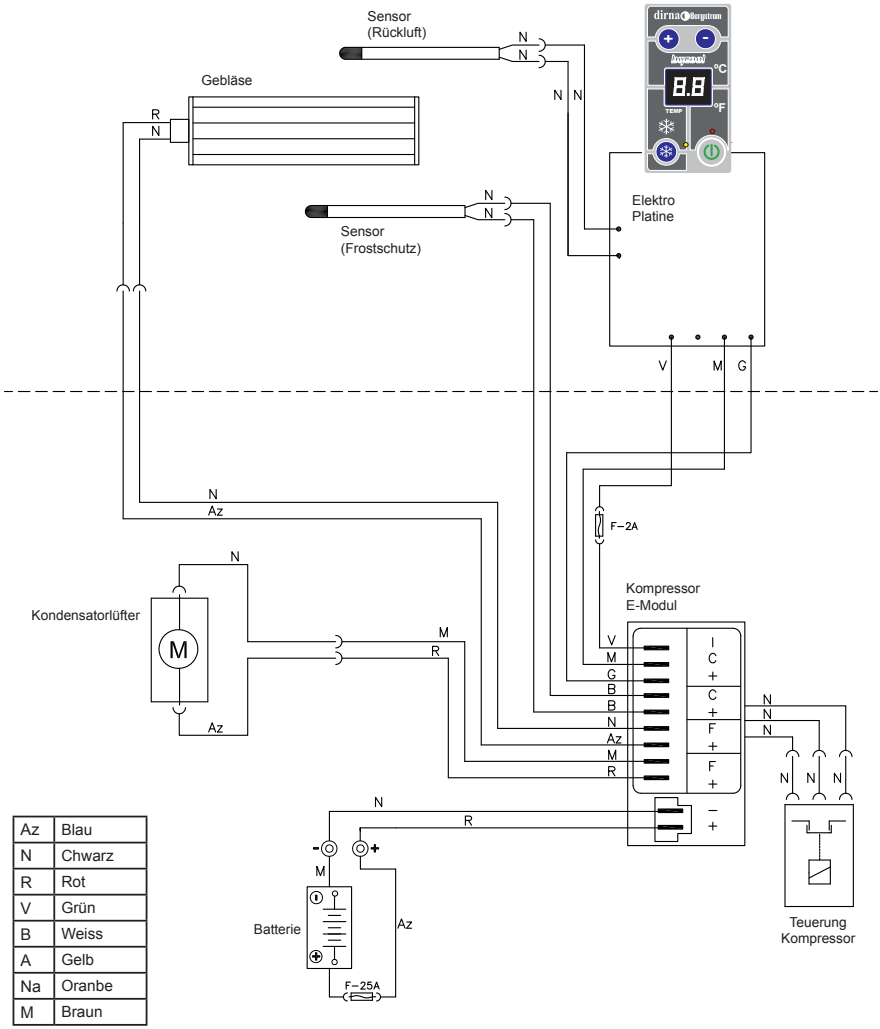

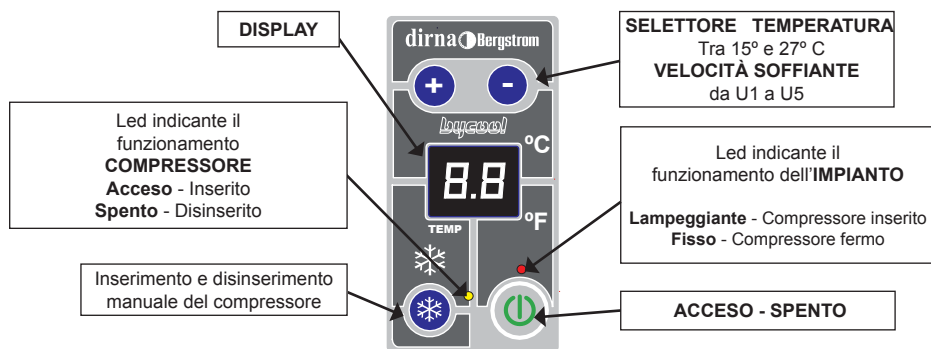

L'impianto dispone di due modi di funzionamento:

F4 Modo automatico.

F0 Modo manuale.

Altre funzioni:

F1 Termometro digitale.

F2 Impostazione del tempo.

F3 Selezione ° F (Fahrenheit).



ATTENZIONE:

Se durante il montaggio si inclina l'impianto o si ribalta la cabina con l'impianto montato, prima di rimettere in funzione l'impianto occorre attendere almeno 60 minuti dal momento in cui è di nuovo in posizione orizzontale.

Quando si avvia, l'impianto funziona automaticamente nel modo **F4** (automatico). Mantenendo premuto il tasto **ON/OFF**, scorrono le funzioni che compaiono sul display **F4, F0, F1, F2, F3**. Rilasciare il tasto quando compare l'opzione richiesta.

Funzione dei tasti

① Accensione / Spegnimento dell'impianto (On/ Off).

Nota: Premendo questo pulsante l'impianto si accende in modo automatico **F4**.

② Controllo delle velocità del ventilatore (solo modo manuale).



Nota: se l'impianto è acceso in modo automatico **F4**, e l'utente preme questo tasto, l'impianto passa al modo manuale **F0**. Così l'utente può scegliere il flusso d'aria richiesto premendo questo tasto, mentre sul display compaiono le sigle **U1, U2, U3, U4, U5, U4, U3, U2, U1**

③ SELETTORE TEMPERATURA



- Tra 15° e 27° C - 59-80° F



PER ATTIVARE IL TELECOMANDO

- Con l'impianto spento, mantenere premuto il tasto  del quadro comandi fino alla comparsa sul display di  lampeggiante. Quando è fisso, toccare qualsiasi tasto del telecomando che così viene riconosciuto. Se non si preme alcun tasto del telecomando entro 30 secondi, l'impianto si spegne (*è possibile programmare fino a 5 telecomandi per lo stesso gruppo*).



PER DISATTIVARE

- Per cancellare qualsiasi telecomando impostato, mantenere premuto il tasto  del quadro comandi, finché sul display non compare  e quindi premere il tasto .

Tutti i telecomandi attivati vengono automaticamente annullati. (*Non lasciare passare più di 30 secondi tra una pulsazione di un tasto e l'altra altrimenti si spegnerà il dispositivo*).







F4 Modo automatico







Sul display compar  alternativamente con la temperatura selezionata. Se la temperatura è superiore a 32° C all'interno del veicolo quando si mette in funzione l'impianto, la soffiante e il compressore funzionano al massimo regime per circa 20 minuti circa, dopodiché la soffiante e il compressore regolano il proprio regime a seconda della temperatura interna.



  Premendo un tasto o l'altro, si imposta la temperatura richiesta, tra 15° e 27° C - 59-80° F.

F0 Modo manuale

Con questa funzione il compressore si avvia al massimo regime con la velocità minima dell'aria. Il compressore si attiva o si disattiva a seconda della temperatura impostata sul display.

Mantenendo premuto , aumenta la velocità della soffiante e sul display compare , , , ,  Rilasciare il tasto quando compare la velocità richiesta.

Mantenendo premuto , diminuisce la velocità della soffiante e sul display compare , , , ,  Rilasciare il tasto quando compare la velocità richiesta.

  Premendo una volta sola un tasto o l'altro, si imposta la temperatura richiesta, tra 15° e 27° C - 59-80° F.



Il compressore e il ventilatore del condensatore si inseriscono e si disinseriscono automaticamente al raggiungimento della temperatura impostata (*ad esempio, temperatura impostata 23°C: il compressore e il ventilatore del condensatore si disinseriscono a 21°C e si inseriscono di nuovo a 24°C*).

Termometro digitale

Segnala la temperatura interna del veicolo. In questo modo di funzionamento, l'impianto è spento.

Impostazione del tempo

Ore di funzionamento e spegnimento da 0 a 9 ore. A 0 ore non effettua la temporizzazione, è in funzionamento manuale **F0**.

Per impostare le ore, usare i tasti  .

Scegliere l'ora che compare sul display, 1H (un'ora), 2H (due ore)...9H (nove ore), e premere il tasto **On/Off** , e selezionare **F4** o **F0**, l'impianto si mette in funzione per il tempo impostato e si ferma una volta trascorso.



Messaggi di errore

Se all'accensione l'impianto emette dei fischi continui, la tastiera è collegata in modo errato o non è collegata.

E0 - Guasto al sensore dell'aria di ritorno.

E6 - Batteria bassa meno di 22.8 V.

E2 - Guasto al ventilatore del condensatore o al ventilatore.

E3 - Guasto compressore (Cause: motore, cablaggio, connettore, mancanza o eccesso di carica)

E5 - Guasto per riscaldamento del modulo elettronico del compressore.

E8 - Guasto al sensore antigelo.

**Importante**

In alcuni casi di messaggio d'errore, per spegnere il dispositivo, mantenere premuto il tasto On/Off  fino a quando si spegne il display.

**Importante**

Se durante il funzionamento l'impianto si spegne, la causa può essere:

- Cavo di comunicazione disinserito o fusibile saltato.
- Fusibile di alimentazione dell'impianto saltato.

Schema elettrico

AVVERTENZA IMPORTANTE!
 Fare attenzione a non invertire le polarità nel collegamento dell'alimentazione dell'impianto. Infatti, in tal caso il quadro comandi non si accende e l'impianto non funziona.

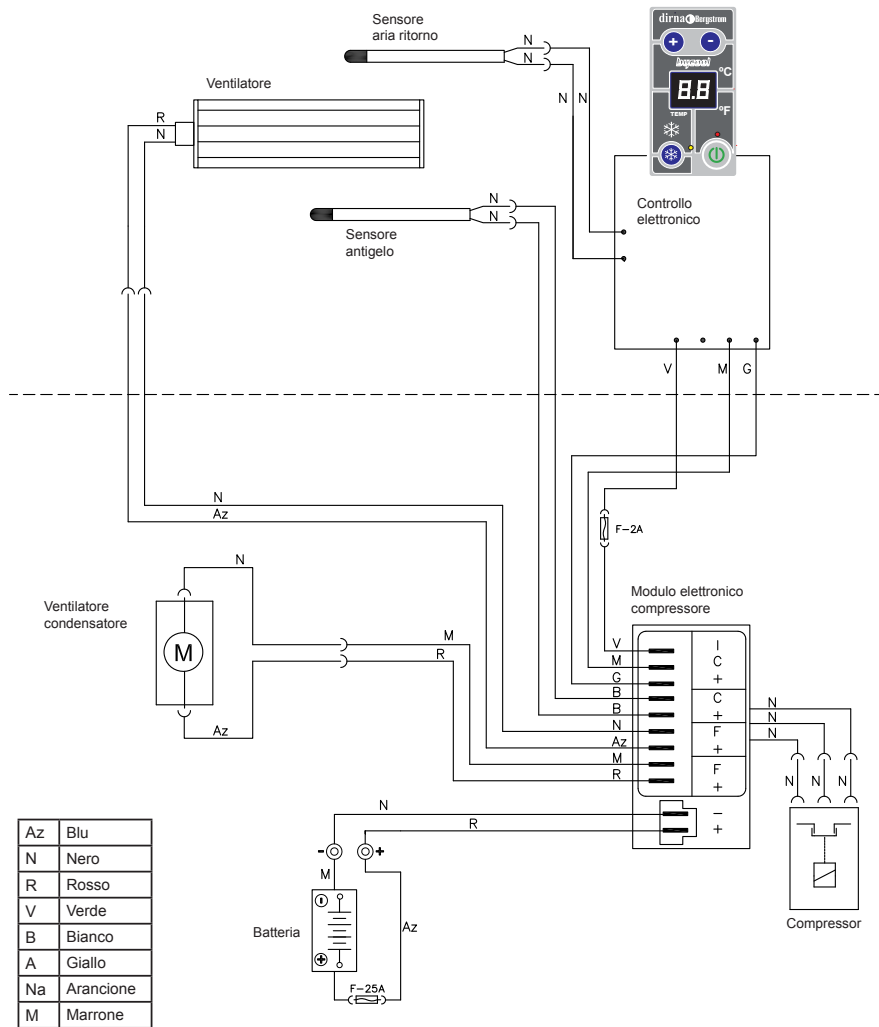

Francisco Alonso, 6
28806 Alcalá de Henares (MADRID)



Contact	Phone	Fax	E-Mail
Sales (Ventas Internacional)	+34 91 8770510	+34 91 8771158	sales@dirna.bergstrominc.com
Comercial Nacional	+34 91 8775841	+34 91 8836321	ventas@dirna.bergstrominc.com
Orders & Deliveries (Logística internacional)	+34 91 8775846	+34 91 8771158	export@dirna.bergstrominc.com
Orders & Deliveries (Logística nacional)	+34 91 8775840	+34 91 8836321	comercial@dirna.bergstrominc.com
Technical Assistance (Internacional)	+49 511 86679681	+49 511 86679710	technicalassistance@dirna.bergstrominc.com
Technical Assistance (Nacional)	+34 91 8775845	+34 91 883 6321	oblanco@dirna.bergstrominc.com

www.dirna.com

Dirna Bergstrom, s.l. es titular de todos los derechos de la presente información.

La presente información es confidencial y queda prohibido cualquier acto de reproducción, distribución, comunicación pública y/o transformación de cualquier elemento de la misma sin la previa y expresa autorización de **dirna Bergstrom, s.l.**

Esta información ha de ser utilizada única y exclusivamente para el fin para el que fue creada, no siendo **dirna Bergstrom, s.l.** responsable de los posibles daños que se pudiera causar al cliente y/o a terceras partes por un incorrecto y/o inadecuado uso de la misma.

Para cualquier aclaración al respecto pueden dirigirse al Centro de Comunicaciones del fabricante **dirna Bergstrom, s.l.**

Dirna Bergstrom, s.l. (Hereinafter DIRNA) is the holder of all the rights of this information.

This information is confidential and it is absolutely forbidden any act of reproduction, distribution, public communication and/or transformation of any element of it without the previous and express authorization of **dirna Bergstrom, s.l.**

This information must be used only and exclusively for what it has been created, **dirna Bergstrom, s.l.** doesn't assume any responsibility of possible damages that could be caused to the client and/or third parties for a wrong and/or inadequate use of it.

For any doubt about the aforementioned please contact **dirna Bergstrom, s.l.** by Communication Centre.

Dirna Bergstrom, s.l. est titulaire de tous les droits de la présente information.

La présente information est confidentielle et tout acte de reproduction, distribution, communication publique et/ou transformation de tout élément lié à cette information est interdit sans l'autorisation préalable et expresse de **dirna Bergstrom, s.l.**

Cette information doit être utilisée uniquement et exclusivement dans le but pour lequel elle a été créée, **dirna Bergstrom, s.l.** n'étant pas responsable d'éventuels dommages pouvant affecter les clients et/ou des tierces personnes dus à une utilisation incorrect et/ou inadéquate de cette information. Pour toute clarification à ce sujet, veuillez vous adresser au Centre de Communications du fabricant **dirna Bergstrom, s.l.**

Dirna Bergstrom, s.l. Ist der Inhaber dieser Information.

Der Inhalt dieser Information ist vertraulich, und die Vervielfältigung, Verteilung, Veröffentlichung bzw. Abänderung von Teilen daran ohne vorherige und schriftliche Genehmigung durch **dirna Bergstrom, s.l.** ist untersagt.

Diese Information darf nur für jenen Zweck verwendet werden, für den sie geschaffen wurde, und **dirna Bergstrom, s.l.** haftet nicht für die möglichen Schäden, die dem Kunden und/oder Dritten durch eine falsche oder ungeeignete Anwendung dieser Information entstehen könnte.

Weitere Informationen hierzu erhalten Sie von der Kommunikationszentrale des Herstellers **dirna Bergstrom, s.l.**

Dirna Bergstrom, s.l. é titolare di tutti i diritti della presente informazione.

La presente informazione é confidenziale ed é vietata qualsiasi forma di riproduzione, distribuzione, comunicazione pubblica e/o trasformazione di qualsiasi elemento della stessa senza la previa ed espressa autorizzazione di **dirna Bergstrom, s.l.**

Questa informazione deve essere usata unicamente ed esclusivamente per la finalità creata. **dirna Bergstrom, s.l.** declina qualsiasi responsabilità dai possibili danni causati al cliente e/o a terzi da un non corretto e/o inadeguato uso della stessa.

Per qualsiasi chiarimento al rispetto rivolgersi al Centro delle Comunicazioni del fabbricante **dirna Bergstrom, s.l.**